

Four® Mat

Design: Strand + Hvass

Table top finishes



Frame colours



Options

Cable duct, single or double

Motorised height adjustment from 68-132,5 cm

Four[®] Mat

EN

Design: Strand + Hvass

1800 x 900

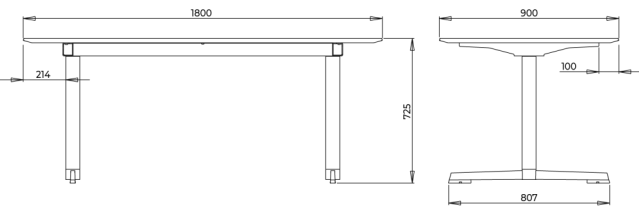

2000 x 1000

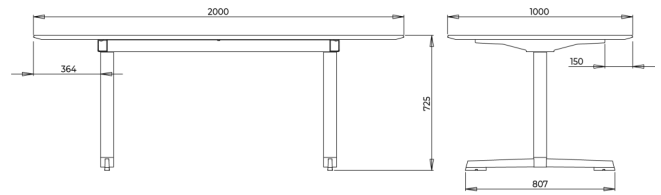

2400 x 1100

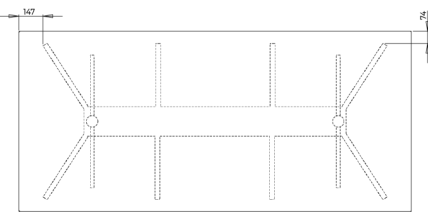
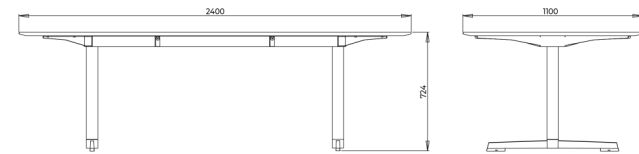

Addition A - 1500 x 1250

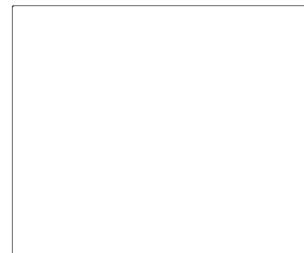
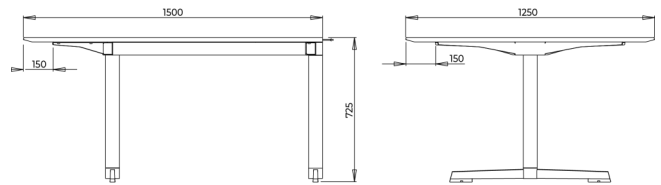

Addition B - 1400 x 1250

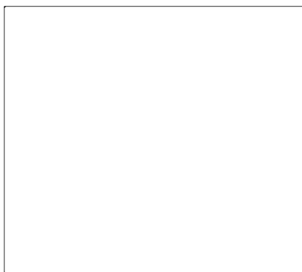
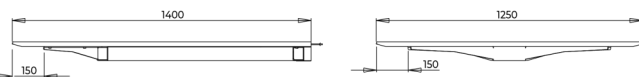

Addition C - 1400 x 1250

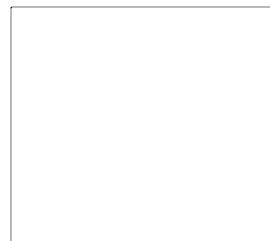
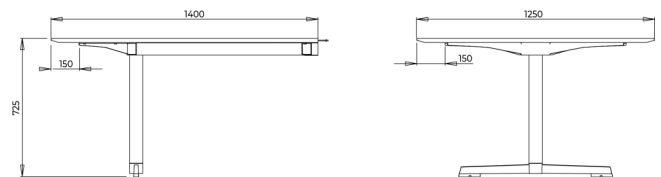

Four[®] Mat

EN

Design: Strand + Hvass

Diameter 1200

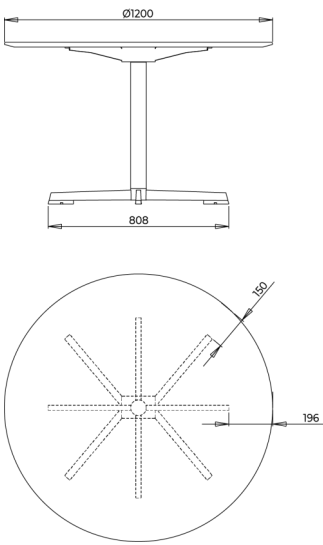

FOUR
DESIGN

AN OCEE
INTERNATIONAL
COMPANY

Design: Strand + Hvass

Materials

Table top variants

Chip board with veneer,
Thickness: 23 mm

Compact laminate,
Thickness: 12 mm

Chip board with high-pressure laminate or Fenix laminate and ABS edge.
Thickness: 23 mm.

Chip board with linoleum and linoleum edges.
Thickness: 23 mm.

Table tops can be delivered FSC certified.

Frame

Legs: Steel: Ø56x3 mm, aluminium: Ø70x1,5 mm.
Beam: Aluminium EN AW-5754.
Gliders: Pa6

Fasteners

Screw: M6x14, pan-head
Screw: M10x90, head cap screw, hexagon socket
Screw: M8x25, head cap screw, hexagon socket
Skive: Ø10

Instructions

Assembly instructions can be found at www.fourdesign.dk under Four Mat.

Quality and Environment

At Four Design, we are aware of our environmental responsibility. We strive to reduce our company, and our customer's impact on the environment by producing quality furniture in a sustainable manner.

Procurement

We procure materials from responsible suppliers who comply with our high standards, ensuring that the materials are sustainably sourced and managed, conforming to applicable laws and regulations such as legal logging and chemical restrictions.

Production

We are ISO14001 certified, guaranteeing excellent environmental standards of our manufacturing sites.

Use

Four Design provides a 5-year warranty on all products within our price list. This warranty covers breakage and damage of products occurring because of deficient craftsmanship performance under normal use. The warranty shall lapse if the product shows signs of mishandling abuse or other physical damage. The warranty does not cover those parts of the product which are exposed to abrasion during use.

We kindly refer to our Maintenance Guide: http://www.fourdesign.dk/pdf/Maintenance_Guide.pdf

Recycling

We are working towards the aim for all our products to be minimum 95% recyclable. Products must be separated into their components and disposed of separately. All metal parts can be disposed of and recycled by an approved organisation. Lacquered frames are treated with a paint classified as not dangerous according to directive 1999/45/EF. Wood can either be recycled or incinerated. Plastic shells can be recycled. The shell will be granulated and reused in new plastic production. Upholstery and veneer shells are not recyclable but can be disposed of by incineration.